

# PIAA SPORTS HORN

## Installation Instructions

Thank you for purchasing the PIAA Sports Horn System

Please read this entire manual before installation and use.  
Your specific installation may require additional wiring connectors  
that are commonly available.

### CAUTION

1. Do not remove or alter the screw or the bracket on the back side of the horns. Doing so may alter their performance or may disable them.
2. Install the horns so the open end with the cover points down.
3. Do not install and wire the PIAA Sports Horns so they work with the factory installed horns. Doing so may overload the circuit or may not pass local noise regulations.
4. Install the PIAA Sports Horn in a location that will not get direct water spray or dust.
5. Install the PIAA Sports Horns in a location that is away from hot engine components.
6. Do not paint or apply any type of chrome plating or powder coating to the PIAA Sports Horn. Doing so may alter the tone or function of the horn.

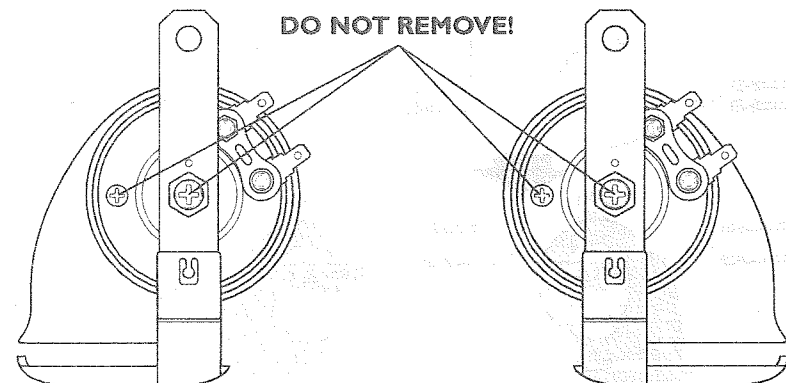

## CONTENTS

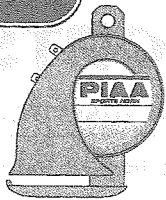

One - horn A

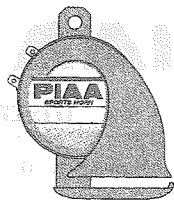

One - horn B



Two - ground(-) wires.

## INSTALLATION

Locate the factory horn(s) and determine what type of installation is involved. There are four wiring installation scenarios (A,B,C,D), study each one and determine which one fits your application.

When mounting the PIAA Sports Horns, mount them to a sturdy location with minimal vibration. Use a suitable fastener of 8mm (5/16") or smaller.

### INSTALLATION TYPE A

Two factory horns with two 1/4" blade connectors each.

1. Unplug the factory horns.
2. With an assistant to honk the horn use a test light or volt meter to determine which wire is positive (+) and negative (-).
3. Connect the positive (+) wires to the top terminals on the PIAA Sports Horns.
4. Connect the negative (-) wires to the bottom terminals on the PIAA Sports Horns.

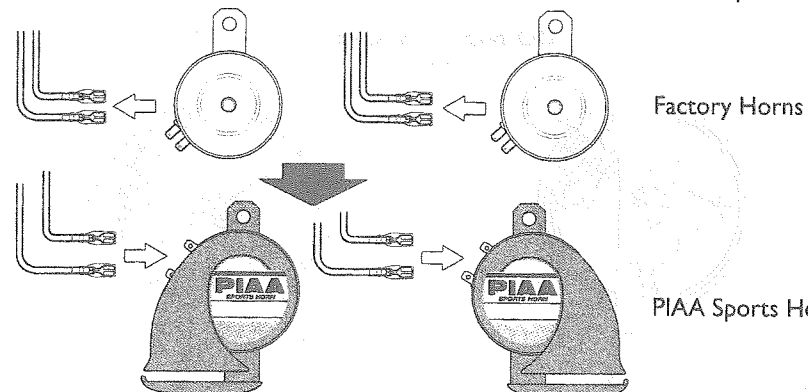

## INSTALLATION (Cont'd)

### INSTALLATION TYPE B

Two factory horns each with a single wire plug.

**PARTS NEEDED:** Two insulated 1/4" female blade connectors

1. Cut off the factory plugs and crimp on insulated 1/4" female blade connectors to each factory positive (+) wire.
2. Plug the new 1/4" female blade connectors to the top terminals on the PIAA Sports Horn.
3. Plug the included ground wires to bottom terminals on the PIAA Sports Horn and ground them to a good chase ground (-).

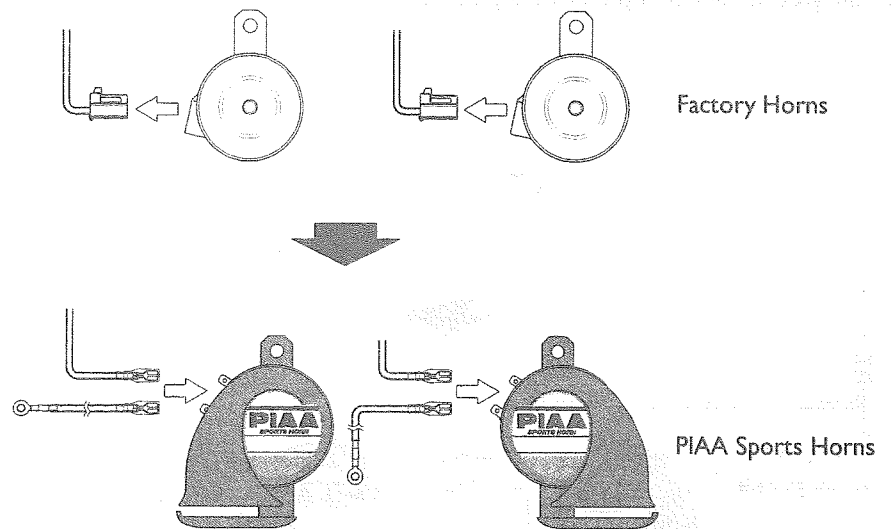

## INSTALLATION (Cont'd)

### INSTALLATION TYPE C

Single factory horn with a single wire plug.

**PARTS NEEDED:** Two insulated 1/4" female blade connectors, approximately 5-6ft of 16AWG insulated wire, one splice connector

1. Cut off the factory plug and splice two lengths of wire to the factory positive (+) horn wire. Make sure the lengths of wire will reach the mounting locations of the PIAA Sports Horns.

2. Crimp an insulated 1/4" female blade connector to the end of each wire that was added.

3. Plug the new 1/4" female blade connectors to the top terminals on the PIAA Sports Horn.

4. Plug the included ground wires to bottom terminals on the PIAA Sports Horn and ground them to a good chasis ground(-).

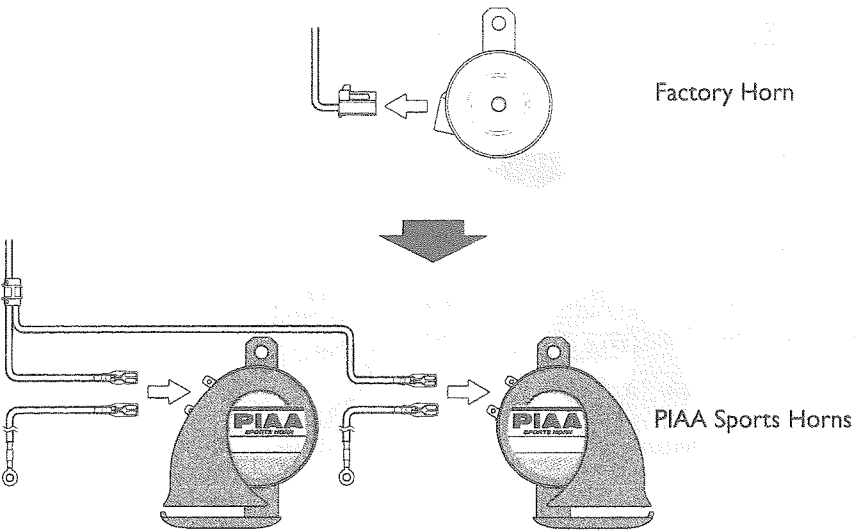

## INSTALLATION (Cont'd)

### INSTALLATION TYPE D

Single factory horn with two 1/4" blade connectors.

**PARTS NEEDED:** Four insulated 1/4" female blade connectors, approximately 5-6ft of 16AWG insulated wire, two splice connectors

1. With an assistant to honk the horn use a test light or volt meter to determine which wire is positive (+) and negative (-)
2. Cut off the factory 1/4" female blade connectors and splice two lengths of wire to the factory positive (+) horn wire. Make sure the lengths of wire will reach the mounting locations of the PIAA Sports Horns.
3. Crimp an insulated 1/4" female blade connector to the end of each wire that was added to the factory positive (+) wire. Connect these positive (+) 1/4" female blade connectors to the top terminals on the PIAA Sports Horns.
4. Cut off the factory 1/4" female blade connectors and splice two lengths of wire to the factory negative (-) horn wire. Make sure the lengths of wire will reach the mounting locations of the PIAA Sports Horns.
5. Crimp an insulated 1/4" female blade connector to the end of each wire that was added to the factory negative (-) wire. Connect these negative (-) 1/4" female blade connectors to the bottom terminals on the PIAA Sports Horns.

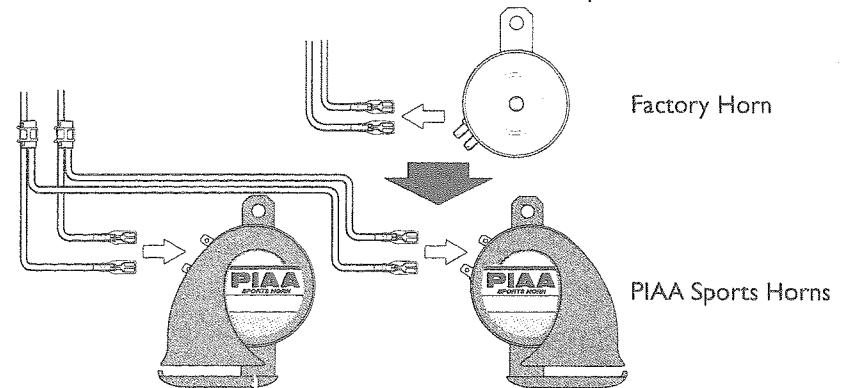

## GENERAL WIRING

