

PIAA 004

Installation Instructions

Thank you very much for purchasing PIAA product.
Please read this entire manual before installation and use of this product.

For Installers

Please give this Installation Manual to customer after installing.



WARNING

- Lighting laws vary state to state, check your local laws before use.
- The lamps get very hot when they have been in use. Do not touch them as they may cause burns.
- After the lights have been on do not place them near flammable objects.
- Do not splash water directly on the hot lamps, as this may cause cracking of the lens due to dramatic change in temperature.
- Do not look directly into the light of the lamps as the bright light may cause eye damage.
- This light system may be used only as high beam auxiliary lighting.
- The lamps and relay harness are to be used only with 12 volt automotive electrical systems.
- Using this light system while the engine is not running will drain the battery.
- Do not repeatedly turn the light system on and off as it will shorten the life of the system.
- Some automobiles generate high voltage at start up and when it is turned off, do not have lights on as you start or turn off your vehicle.
- Using the wrong bulbs may cause a malfunction, use only specified PIAA bulbs.
- When changing bulbs or lenses follow the lamp assembly/disassembly diagram.
- Leave at least 1/8" clearance between the lamps and the front spoiler, as the heat may damage the spoiler.



CONTENTS

Two (2) PIAA 004 lamps



One (1) PIAA preassembled relay harness with fuse and switch

Hex wrench



Two (2) adhesive pads

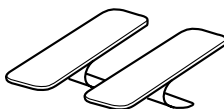

One (1) piece of Velcro

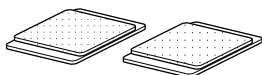

One (1) PIAA one touch connector

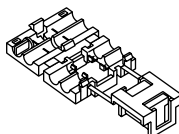

Five (5) wire ties



TOOLS

Vinyl electrical tape



Diagonal cutters

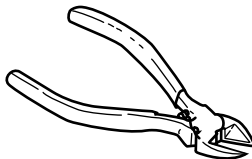

Pliers

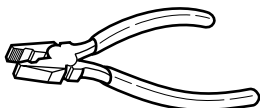

Phillips driver (medium)

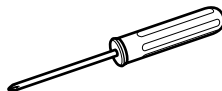

LAMP INSTALLATION

- The work site must be clean and level with enough working space to complete the job without distractions.
- When mounting the lamps mount them in such a place that they are free of obstructions. Do not mount the lamps in such a place that they will obstruct an existing automotive function. Do not mount them in such a manner that they have a chance of contacting the road or curbs.
- The PIAA 004 may be mounted upright or hanging down. It is very important to make sure the "PIAA" that is molded into the lens reads right side up. If it will not read right side up in its mounting location then the bracket will have to be removed and repositioned so that it will mount right side up.

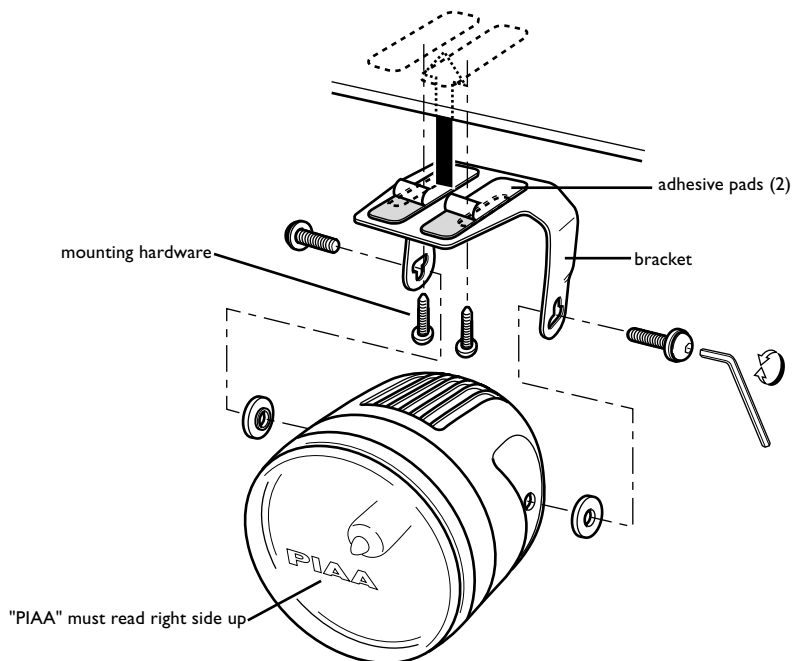

- When a mounting location is decided upon mount the lamp with the supplied mounting screws, adhesive pads or other fasteners that will provide a secure fitting to the vehicle.
- When lamp is mounted make sure to leave 1/8" clearance around the lamp for proper heat dissipation and to protect painted surfaces from heat damage.

HARNES INSTALLATION

1. Before connecting any wires, the negative (-) battery terminal should be disconnected.

When connecting the wires on the harness, follow the wiring diagram and connect them as in the diagram.

2. For proper lamp operation it is recommended that you connect the positive (+) and negative (-) power supply wires directly to the corresponding battery terminals. Do not take power directly from the alternator.

3. Find a power source to connect the switch power wire to. For legal operation of driving lights, the power source must be one that is only powered when the high beam of the headlamps is on. To make this connection use the supplied connector or any connector that is suitable for this application.

Do not connect lights to turn signals or to lights that flash with an automotive alarm.

4. When running the wires through the engine compartment be sure to keep them securely away from moving parts such as the fan and the throttle cable and away from hot parts such as the exhaust manifold.

5. When the wiring is complete, test the system for operation. Do this by turning on the system. If the system works, securely fasten the relay boxes and fuse holders or tie them out of the way with wire ties. If the system does not come on, please contact your PIAA dealer for assistance.

WIRING DIAGRAM

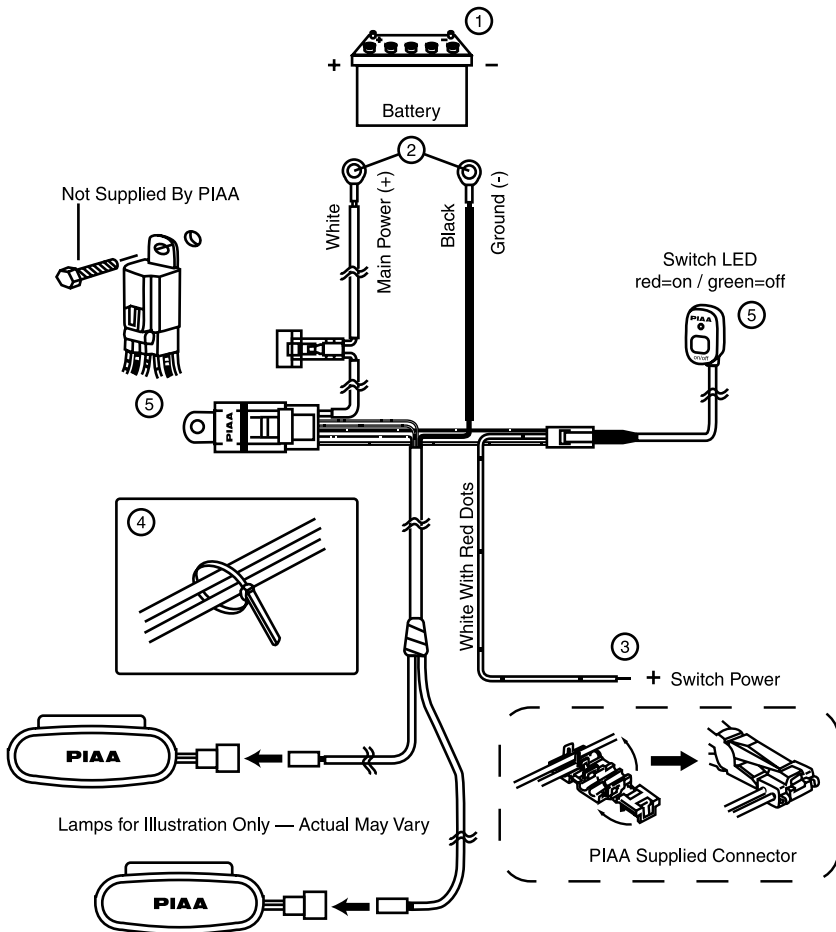

DRIVING LIGHT AIMING

Typically, driving lights are mounted above the front bumper about 14-30 inches from the ground to provide extra high beam illumination. Driving lights can be mounted below the bumper, although they will not be as effective because the light will hit the ground sooner and reduce the range of the light.

Visual aim is made with the center of the beam hot spot 1.5 inches below the lamp center at 25 feet with the lamp facing straight forward. (see below.)

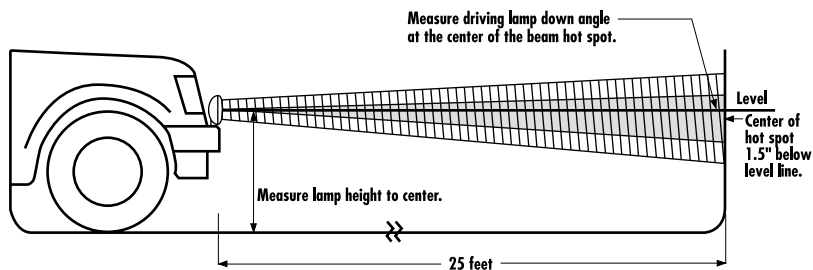

CAUTION

Do not use driving lights into oncoming traffic.

Driving lights should never be the only forward light source.

Driving lights should only be used with the headlamp high beams.

LAMP SERVICE

The PIAA 004 lamps have a replaceable H3 style bulb.
Use only 12V-H3-55 Watt bulbs.

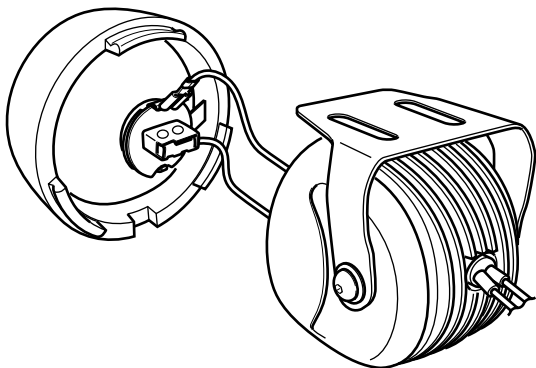

Snap front lens unit off from housing. Be careful not to pull too hard and damage wires.

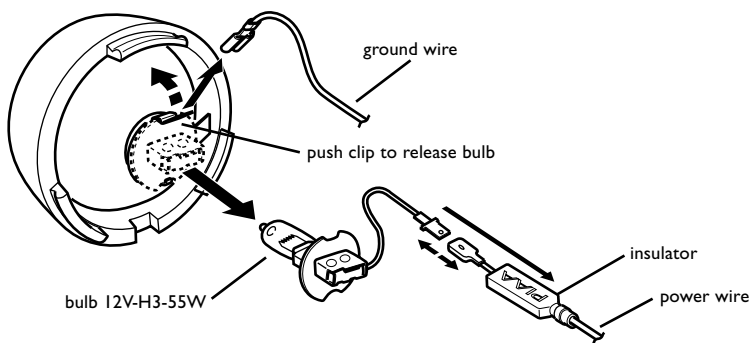

WARNING
Slide insulator over connector.

When service is complete snap lens unit back onto housing being careful not to pinch any wires.

PIAA LIMITED WARRANTY

With the exception of bulbs, PIAA Corporation, USA ("PIAA") warrants its products to be free from defects in workmanship and materials under normal use for as long as the original purchaser owns them.

EXCLUSIONS

This Limited Warranty specifically excludes defects resulting from misuse, abuse, neglect, alteration, modification, improper installation, unauthorized repairs, submersion, theft, vehicle crash, or by any other type of impact. Except for the Limited Warranty stated above, there are no warranties of PIAA products or any part thereof, whether express or implied. Any implied warranty of merchantability or any warranty of fitness for a particular purpose is expressly disclaimed. Some states do not permit the disclaimer of implied warranties.

LENS CRACKS

Crash or impact damage is not covered. This can be determined by a chip or scrape on the lens or the housing. Stress cracks sometimes occur when the lens is subjected to sudden and extreme temperature changes. A stress crack has no chip or other sign of impact. Stress cracks are covered under warranty.

EXCLUSION OF DAMAGES

In no event shall PIAA be liable for any damages whatsoever (including, without limitation, consequential damages, incidental damages, or damages for loss of use, loss of business profits, business interruption, loss of business information, loss of time, inconvenience, or other losses) arising out of the use, misuse, or inability to use a PIAA product. PIAA reserves the right to change the design its products without any obligation to modify any previous product. This warranty gives you specific legal rights. You may also have other rights that vary from state to state.

REPAIR AND REPLACEMENT

If a PIAA product is suspected of being defective, it must be submitted freight prepaid, to either an authorized dealer or distributor for warranty inspection. The receipt or other proof of purchase and a description of the problem must be included. The returned product will be inspected. If the product is found to be defective and covered by this Limited Warranty, the sole remedy is repair or replacement, at PIAA's option. A repaired or replacement product will be shipped back at no charge, and will be warranted to be free from defects in workmanship and materials under normal use for as long as the original purchaser owns it. Removal, installation, or reinstallation costs are not covered by this Limited Warranty.

PIAA CORPORATION, USA
15370 SW Millikan Way
Beaverton, Oregon 97006
Telephone: 503.643.7422
Fax: 503.643.9144
Web: www.piaa.com